

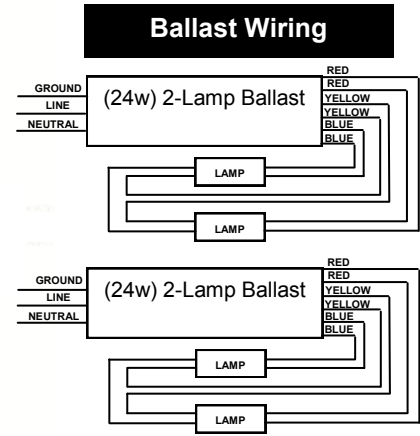

## 2x2 Office Fixture Installation Instructions

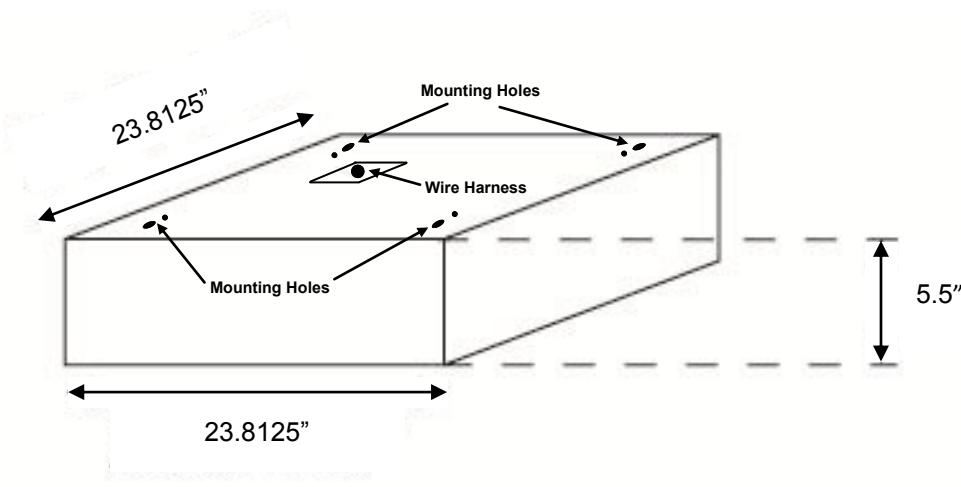

### Fixture Mounting & Wiring

1. Disconnect power at the circuit breaker or disconnect fuse. Always shut off power when installing and/or repairing any electrical appliance. Failure to comply may result in severe injury or death.
2. The 2x2 Office fixture is designed to be a recessed ceiling fixture. Suspension cables or chain mounting can be connected to the pre-drilled holes located on either end of the back side of the fixture.
3. There is a wiring harness with a connector protruding out of the fixture's access door knock-out. This connector can (A); direct connect to circuit wiring or (B); connect to power cords that were supplied with fixture.

(A) For the direct wire connection option, connect a pigtail (has bare wires at one end) to the wire harness. These can be wired directly to a circuit and will allow you to install any strain relief connector in the access door knock-out.

(B) For supplied power cords, plug the two connectors together and press the snap-in style strain relief into the knock-out on the access door. Make sure the tabs on the strain relief are securely placed within the knock-out.

4. Install bulbs if necessary then turn on circuit and/or plug in fixture.



### CAUTIONS

1. The product shall be installed by a certified individual in compliance with installation code. To avoid the possibility of electrical shock, turn off power supply and allow lamp to cool before installation, replacement or repair.
2. Efficient and reliable grounding is a necessity for personal protection, as well as proper use of the electronic ballast in order to meet the national standard of EMC without interference to the equipment.
3. The luminaires shall be installed in an area with good ventilation, no corrosive gas, no combustible or explosive objects and with ambient temperatures ranging between -20°F to 122°F.
4. The supply voltage is variable between -10% and +10%. The supply voltage will influence the normal start and operation of lamp as well as damage the electronic ballast if outside this range.